

A

B

C

D

E

F

A

B

C

D

E

F

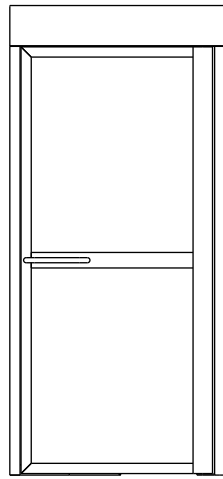

FIGURE A

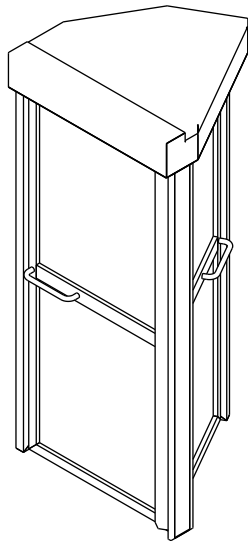

FIGURE B

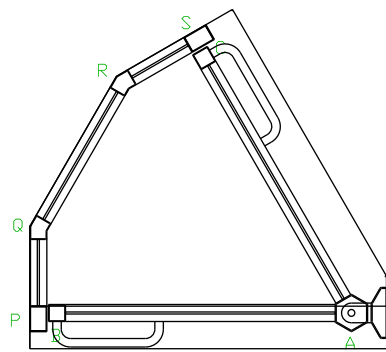

FIGURE C

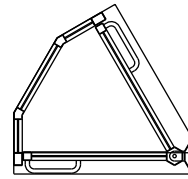

FIGURE 1

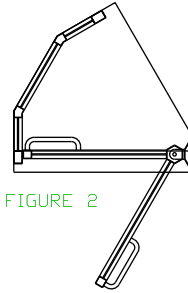

FIGURE 2

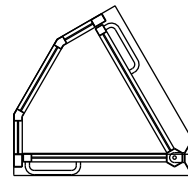

FIGURE 3

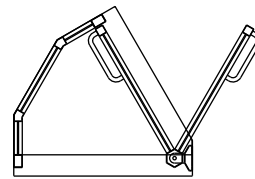

FIGURE 4

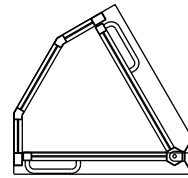

FIGURE 5

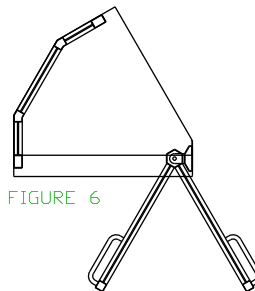



FIGURE 6

Itemref	Quantity	Title/Name, designation, material, dimension etc			Article No./Reference	
Designed by		Checked by	Approved by - date	File name	Date	Scale
 Security Technical Services (Pty) Ltd				ROTADOOR		
				Edition	Sheet	